

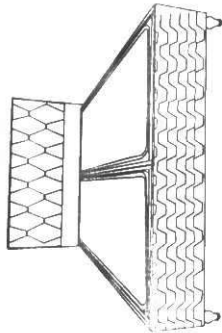

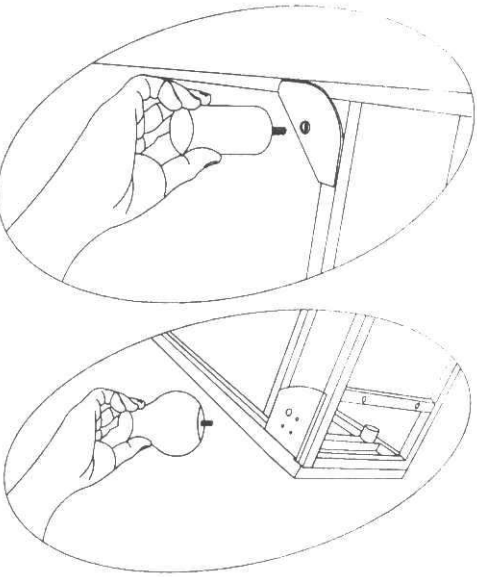



LATHE LEGS SET-UP DIAGRAM

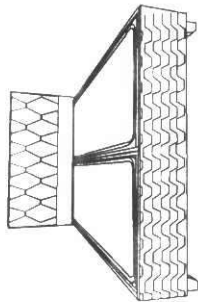
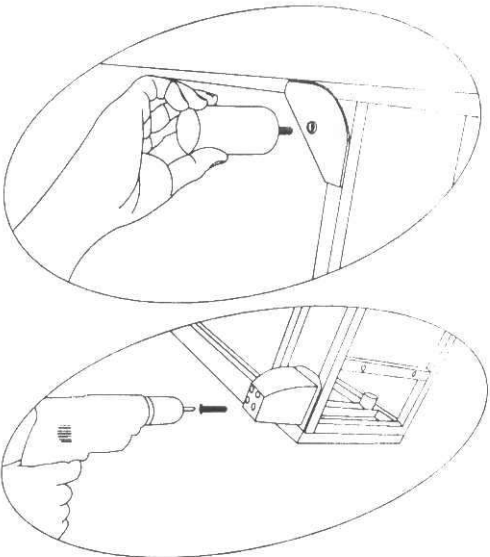

	4 PIECES
	4 PIECES



CUBIC LEGS SET-UP DIAGRAM





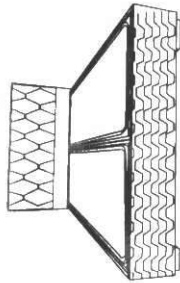
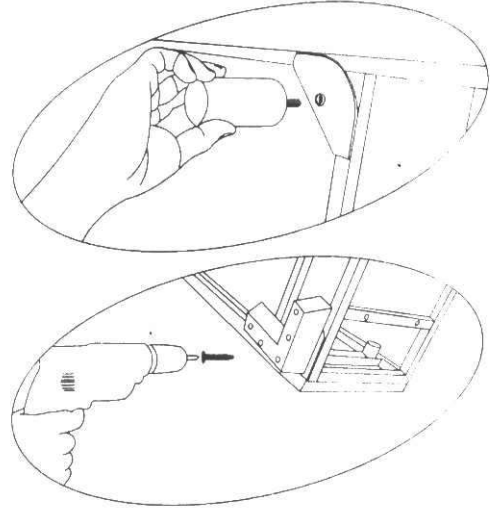

	12 PIECES
	4 PIECES
	4 PIECES

L LEGS SET-UP DIAGRAM

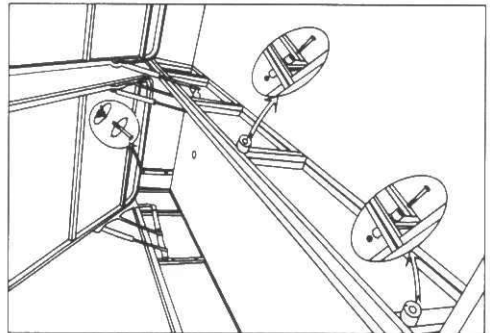







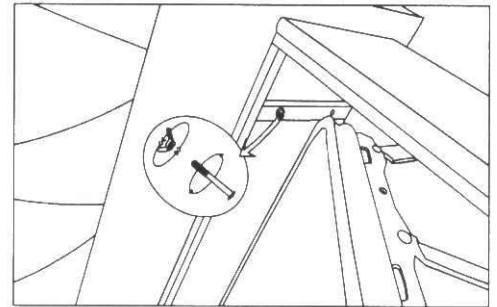

	12 PIECES
	4 PIECES
	4 PIECES









	2 PIECES		4 PIECES		2 PIECES
---	----------	---	----------	---	----------



	4 PIECES		4 PIECES
---	----------	---	----------

			CUBIC LEGS
			PLASTIC LEGS

	SCREW		LATHE LEGS
	L LEGS		LEGS SCREW
	LEGS SCREW		LEGS SCREW