

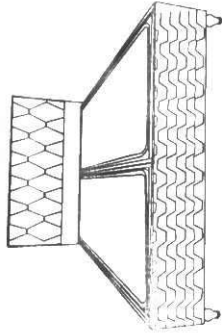

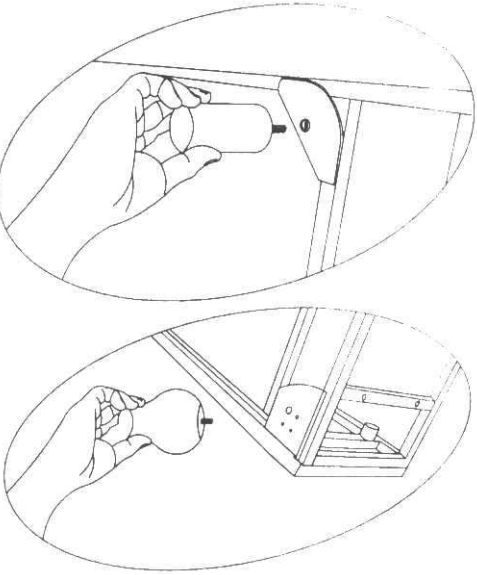



LATHE LEGS SET-UP DIAGRAM

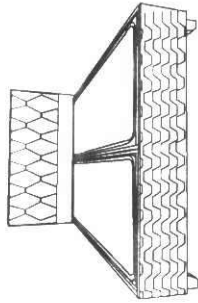
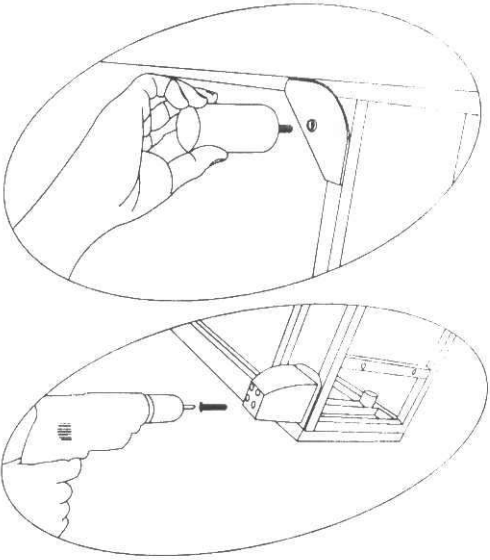

	4 PIECES
	4 PIECES



CUBIC LEGS SET-UP DIAGRAM





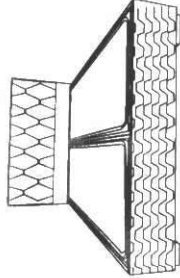
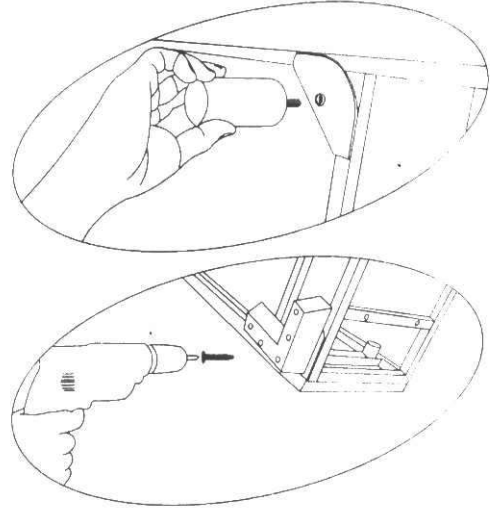

	4 PIECES
	4 PIECES
	12 PIECES

L LEGS SET-UP DIAGRAM

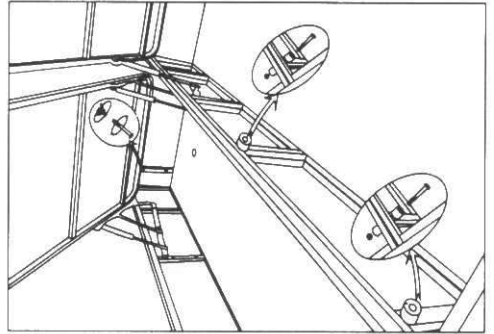







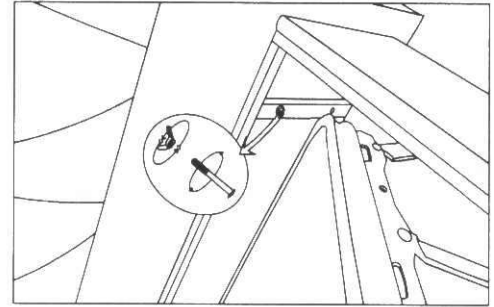













	4 PIECES
	12 PIECES
	4 PIECES



	2 PIECES
	4 PIECES
	2 PIECES



	4 PIECES
	4 PIECES

	BAD BASE STOPPER		CUBIC LEGS
	STOPPER SCREW		CUBIC LEGS
	STRIP NUT		CUBIC LEGS
	BUTTERFLY NUT		CUBIC LEGS
	SCREW		CUBIC LEGS
	LATHE LEGS		CUBIC LEGS
	L LEGS		CUBIC LEGS
	LEGS SCREW		CUBIC LEGS
	LEGS SCREW		CUBIC LEGS