

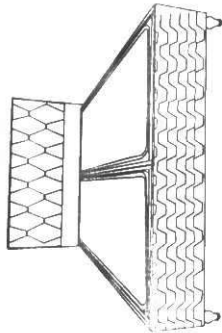

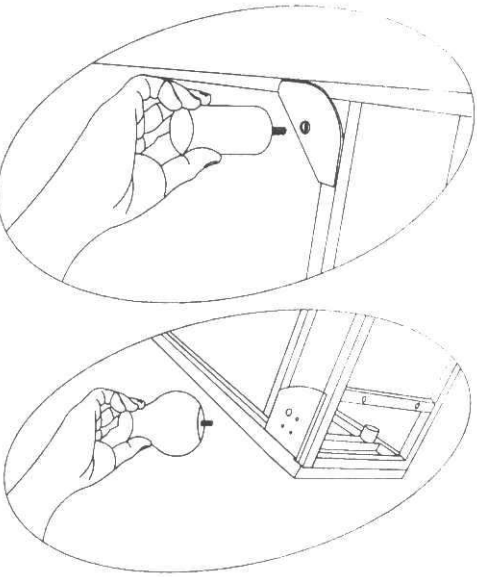



LATHE LEGS SET-UP DIAGRAM

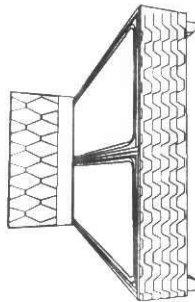
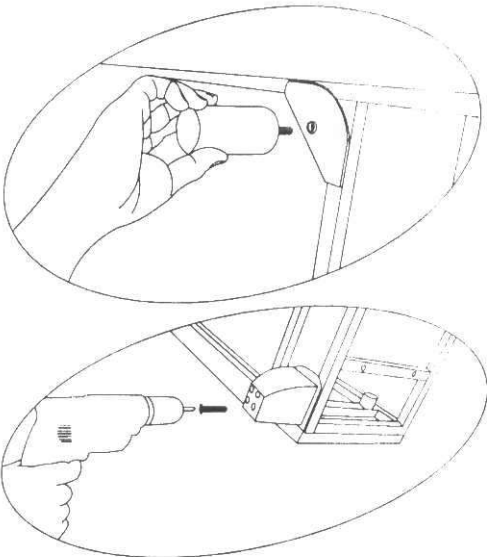

	4 PIECES
	4 PIECES



CUBIC LEGS SET-UP DIAGRAM





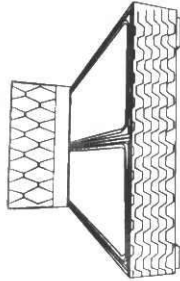
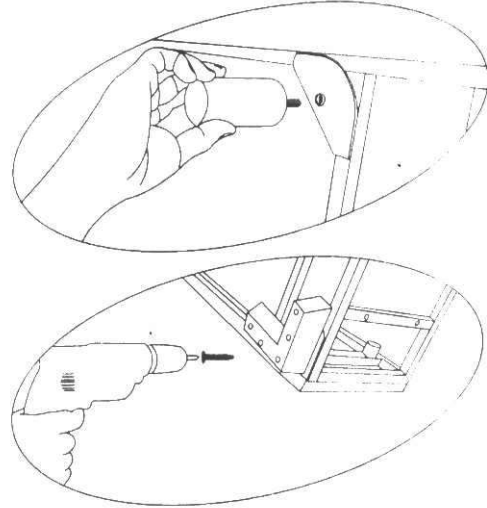

	12 PIECES
	4 PIECES
	4 PIECES

L LEGS SET-UP DIAGRAM

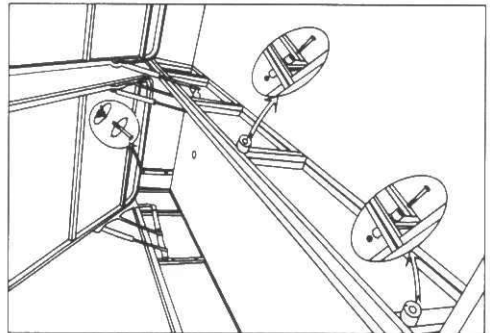







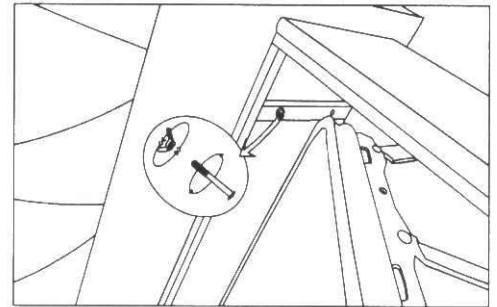



	12 PIECES
	4 PIECES
	4 PIECES











	2 PIECES
	4 PIECES
	2 PIECES



	4 PIECES
	4 PIECES

	BAD BASE STOPPER		CUBIC LEGS
	STOPPER SCREW		CUBIC LEGS
	STRIP NUT		CUBIC LEGS
	BUTTERFLY NUT		CUBIC LEGS

	SCREW		LATHE LEGS
	L LEGS		LATHE LEGS
	LEGS SCREW		L LEGS
	LEGS SCREW		L LEGS