

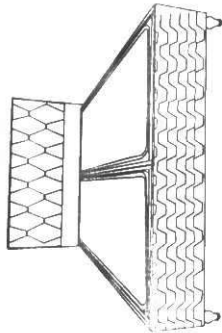

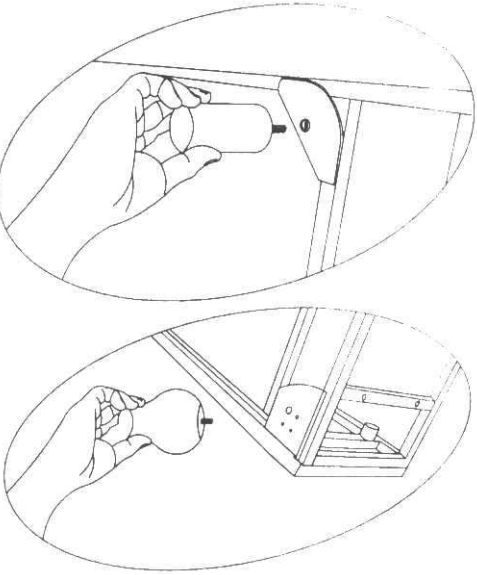



LATHE LEGS SET-UP DIAGRAM

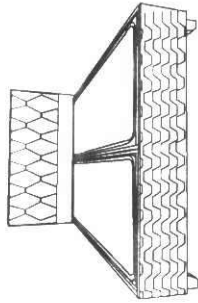
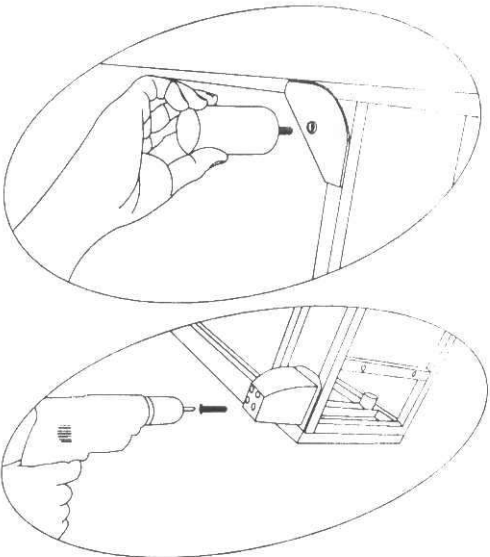

	4 PIECES
	4 PIECES



CUBIC LEGS SET-UP DIAGRAM





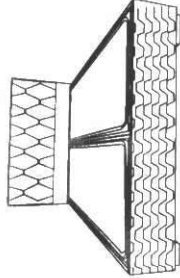
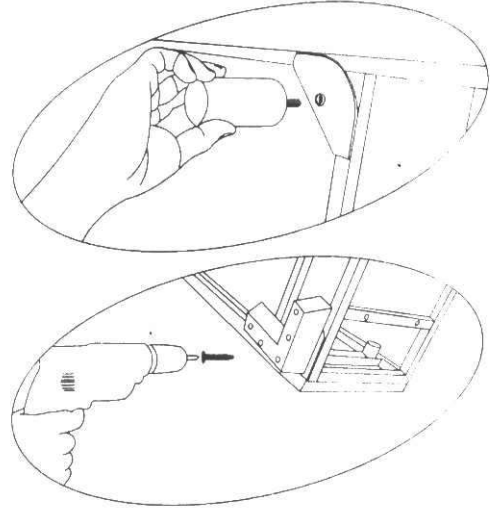

	12 PIECES
	4 PIECES
	4 PIECES

L LEGS SET-UP DIAGRAM

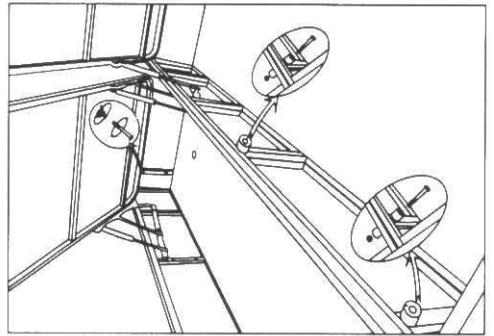





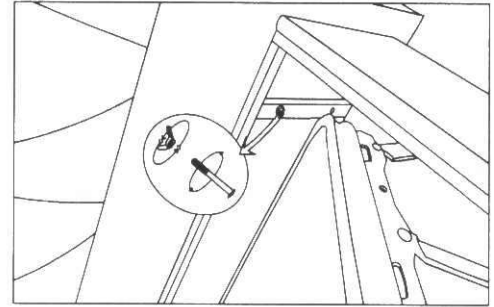

	12 PIECES
	4 PIECES
	4 PIECES











	2 PIECES
	4 PIECES
	2 PIECES



	4 PIECES
	4 PIECES

	BAD BASE STOPPER		CUBIC LEGS
	STOPPER SCREW		PLASTIC LEGS

	BUTTERFLY NUT		LATHE LEGS
	STRIP NUT		L LEGS
	SCREW		LEGS SCREW
	LATHE LEGS		LEGS SCREW